



Automotive Schottky Barrier Diode designed for compact and efficient designs. AEC-Q101 qualified Schottky Barrier Diode and PPAP capable suitable for automotive applications.

Features

- Small Interterminal Capacitance
- Less Parasitic Components
- Small Forward Voltage
- Small-sized Package
- Pb-Free, Halogen Free and RoHS Compliant
- AEC-Q101 Qualified and PPAP Capable

Typical Applications

- Microwave and Submilliwave Mixer
- Microwave and Submilliwave Detector

Specifications

Table 1. ABSOLUTE MAXIMUM RATINGS

Parameter	Symbol	Value	Unit
		-	°

NSVR201MX

Table 2. ORDERING INFORMATION

Device	Marking	Package	Shipping
		-	

Table 3. ELECTRICAL CHARACTERISTICS

Parameter	Symbol	Conditions	Value			Units
			Min	Typ	Max	
		μ				

Figure

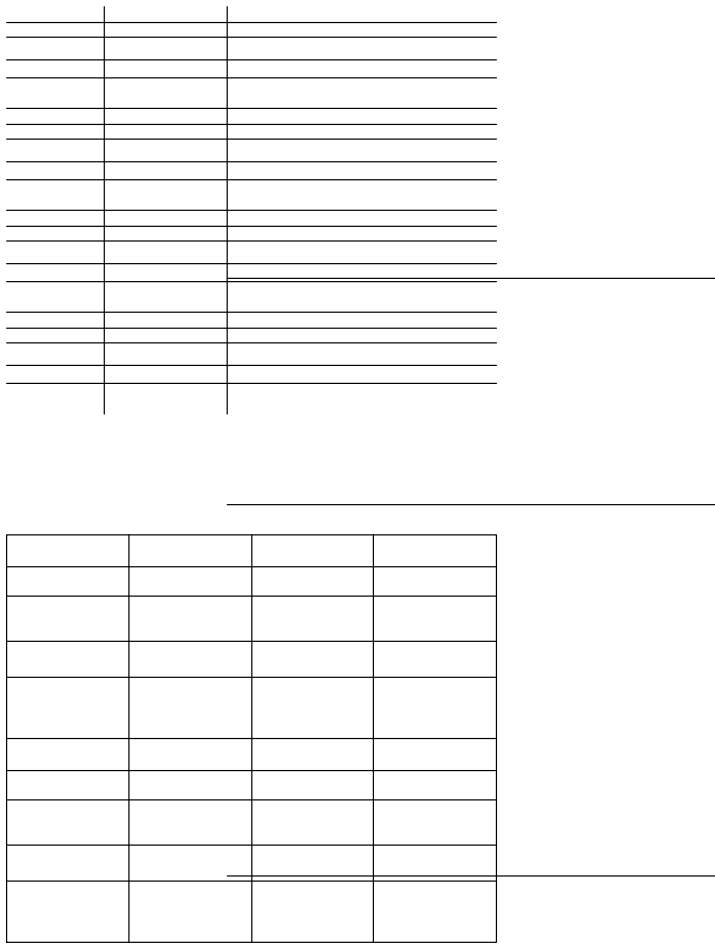
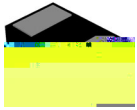
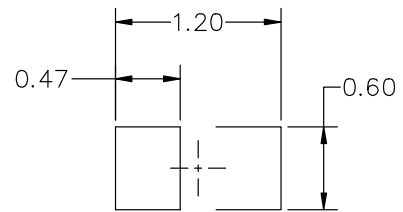
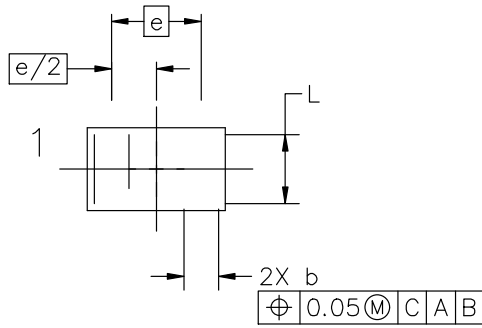
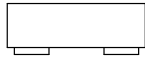
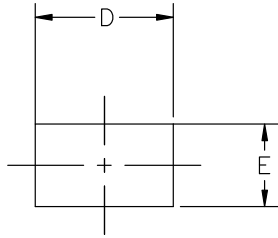

Figure 1.



X2DFN2 1.00x0.60x0.37, 0.65P



GENERIC MARKING DIAGRAM*

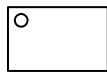

onsemi, **onsemi**, and other names, marks, and brands are registered and/or common law trademarks of Semiconductor Components Industries, LLC dba "**onsemi**" or its affiliates and/or subsidiaries in the United States and/or other countries. **onsemi** owns the rights to a number of patents, trademarks, copyrights, trade secrets, and other intellectual property. A listing of **onsemi**'s product/patent coverage may be accessed at www.onsemi.com/site/pdf/Patent-Marking.pdf. **onsemi** reserves the right to make changes at any time to any products or information herein, without notice. The information herein is provided "as-is" and **onsemi** makes no warranty, representation or guarantee regarding the accuracy of the information, product features, availability, functionality, or suitability of its products for any particular purpose, nor does **onsemi** assume any liability arising out of the application or use of any product or circuit, and specifically disclaims any and all liability, including without limitation special, consequential or incidental damages. Buyer is responsible for its products and applications using **onsemi**
