

CAT3603

3-Channel LED Driver in 3 x 3 mm Package

Description

The CAT3603 is a charge pump LED driver operating in either 1x (LDO) mode or 1.5x fractional mode regulating current through each of the 3 LED pins. Operation at a constant switching frequency of 1 MHz allows the use of very small value ceramic capacitors.

The CAT3603 drives 3 white LEDs in parallel and provides tightly matched regulated current to achieve uniform brightness in LCD backlighting applications. An external resistor, RSET, controls the output current level. The device can deliver up to 30 mA over an input voltage supply range from 3 V to 5.5 V, making it ideal for battery-powered applications.

LED dimming can be accomplished using several methods; using a DC voltage to set the RSET pin current, applying a PWM signal on the EN pin, or adding a switched resistor in parallel with RSET. The EN input pin allows the device to be placed in power-down mode with “near-zero” quiescent current.

The device is available in the tiny 12-lead thin DFN 3 mm x 3 mm package with a max height of 0.8 mm.

Features

- Drives up to 3 LEDs
- Current Setting Resistor
- Compatible with Supply Voltage of 3 V to 5.5 V
- Power Efficiency up to 91%
- Output Current up to 30 mA per LED
- Fractional Pump 1x/1.5x
- Low Noise Input Ripple
- Fixed High Frequency Operation 1 MHz
- “Zero” Current Shutdown Mode
- Soft Start and Current Limiting
- Short Circuit Protection
- 12-lead TDFN 3 mm x 3 mm Package
- This Device is Pb-Free, Halogen Free/BFR Free and RoHS Compliant

Applications

- LCD Display Backlight
- Cellular Phones
- Digital Still Cameras
- Handheld Devices



<http://onsemi.com>

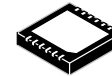

TDFN-12
HV2 SUFFIX
CASE 511AN

PIN CONNECTIONS

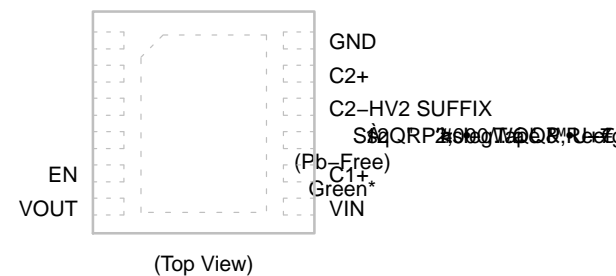

* Lead Finish Matte-Tin

CAT3603

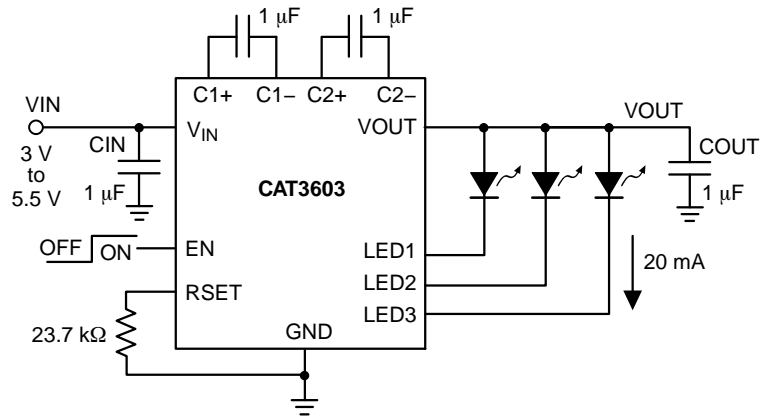

Note: Unused LED channels must be connected to VOUT.

Figure 1. Typical Application Circuit

Table 1. ABSOLUTE MAXIMUM RATINGS

Parameter	Rating	Unit
VIN, VOUT, LEDx voltage	-0.3 to 7.0	V
EN voltage	-0.3 to VIN	V
RSET voltage	-0.3 to VIN	V
Junction Temperature Range	-40 to +150	°C
Storage Temperature Range	-65 to +160	°C
Lead Temperature	300	°C
ESD Rating HBM (Human Body Model)	2,000	V
ESD Rating MM (Machine Model)	200	V

Stresses exceeding Maximum Ratings may damage the device. Maximum Ratings are stress ratings only. Functional operation above the Recommended Operating Conditions is not implied. Extended exposure to stresses above the Recommended Operating Conditions may affect device reliability.

Table 2. RECOMMENDED OPERATING CONDITIONS

Parameter	Range	Unit
VIN	3 to 5.5	V
Ambient Temperature Range	-40 to +85	°C
Input, Output, Bucket Capacitors	1 ±20% typical	µF
I _{LED} per LED pin	0 to 30	mA

1. Typical application circuit with external components is shown above.

CAT3603

Table 3. ELECTRICAL OPERATING CHARACTERISTICS

(VIN = 3.6 V, EN = High, TAMB = 25°C over recommended operating conditions unless otherwise stated.)

Symbol	Parameter	Conditions	Min	Typ	Max	Units
IQ	Quiescent Current	V _{EN} = 0 V, shutdown mode		0.1	1	μA
		1x Mode, No Load		0.4	1	mA
		1.5x Mode, No Load		2.7	5	mA
V _{RSET}	RSET Regulated Voltage		1.17	1.2	1.23	V
I _{LED}	Programmed LED Current	I _{RSET} = 5 μA		2.4		mA
		I _{RSET} = 37 μA		15.0		
		I _{RSET} = 78 μA		30.0		
I _{LED-ACC}	LED Current Accuracy	0.5 mA ≤ I _{LED} ≤ 3 mA		±15		%
		3 mA ≤ I _{LED} ≤ 30 mA		±5		
I _{LED-DEV}	LED Channel Matching	(I _{LED} - I _{LEDAVG}) / I _{LEDAVG}		±3		%
R _{OUT}	Output Resistance (Open Loop)	1x Mode				
		1.5x Mode, I _{OUT}				

CAT3603

TYPICAL CHARACTERISTICS

(VIN = 3.6 V, IOUT = 60 mA (3 LEDs at 20 mA), C1 = C2 = CIN = COUT = 1 μF, TAMB = 25°C unless otherwise specified.)

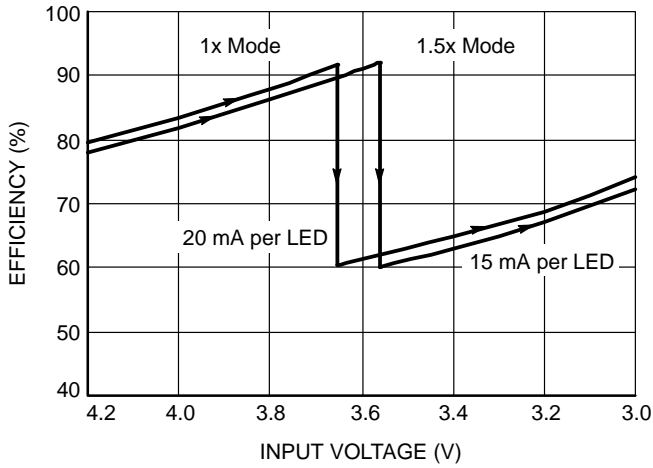

Figure 2. Efficiency vs. Input Voltage (3 LEDs on)

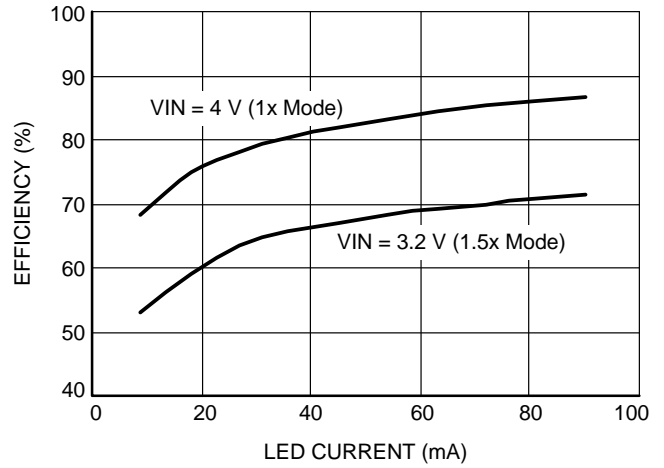

Figure 3. Efficiency vs. Total LED Current (3 LEDs)

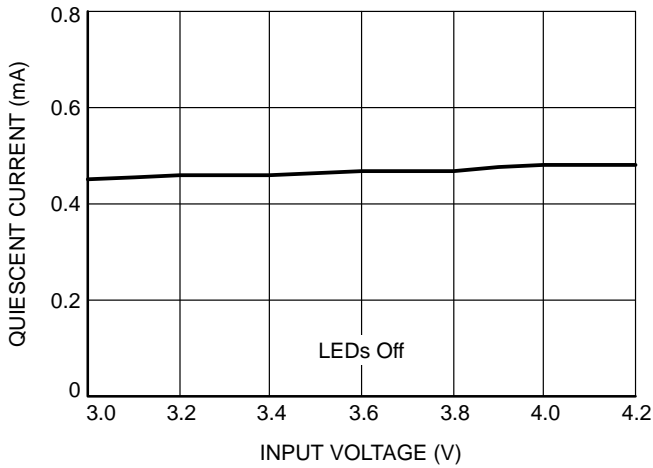

Figure 4. Quiescent Current vs. Input Voltage (1x Mode)

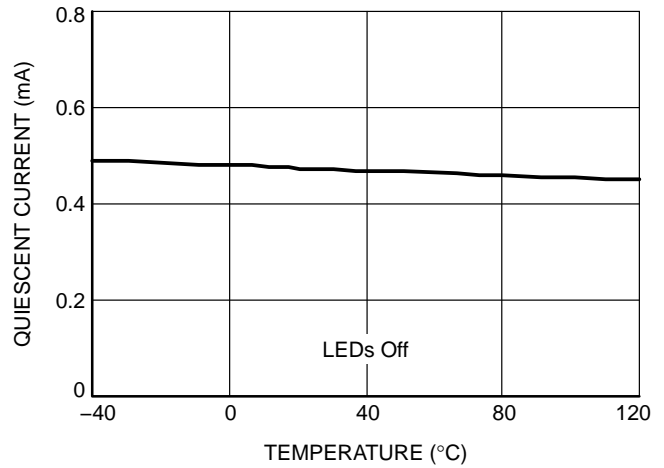

Figure 5. Quiescent Current vs. Temperature (1x Mode)

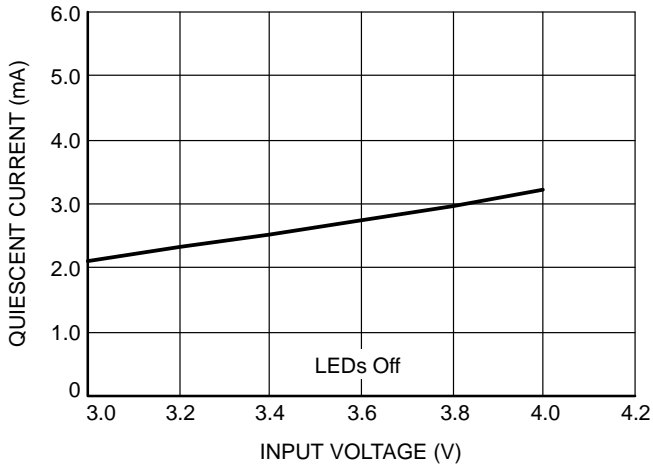

Figure 6. Quiescent Current vs. Input Voltage (1.5x Mode)

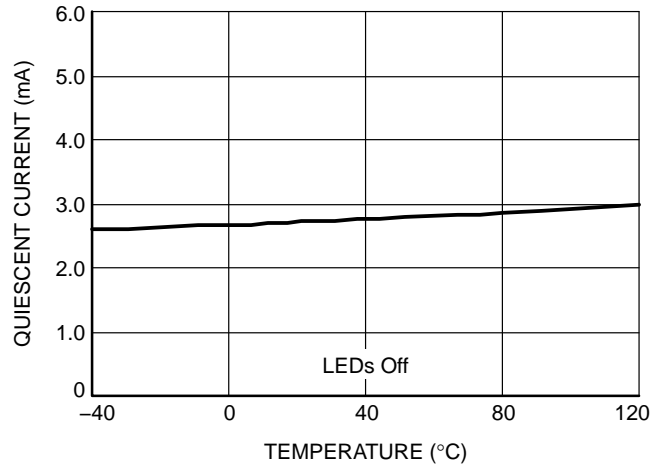

Figure 7. Quiescent Current vs. Temperature (1.5x Mode)

CAT3603

TYPICAL CHARACTERISTICS

(VIN = 3.6 V, IOUT = 60 mA (3 LEDs at 20 mA), C1 = C2 = CIN = COUT = 1 μF, TAMB = 25°)

CAT3603

TYPICAL CHARACTERISTICS

(VIN = 3.6 V, IOUT = 60 mA (3 LEDs at 20 mA), C1 = C2 = CIN = COUT = 1 μF, TAMB = 25°C unless otherwise specified.)

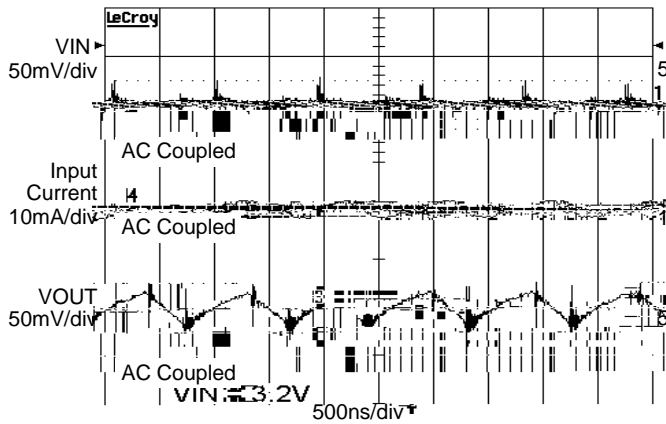

Figure 14. Switching Waveforms in 1.5x Mode

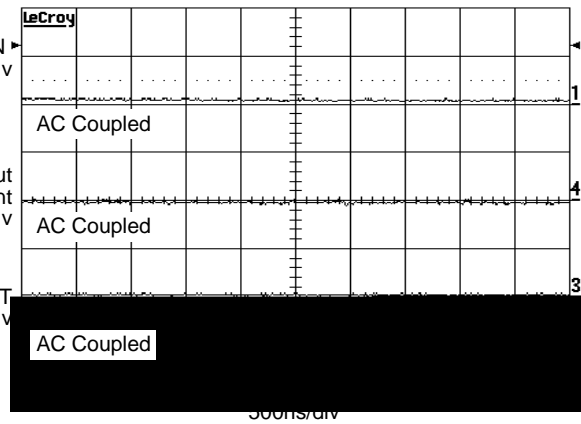

Figure 15. Operating Waveforms in 1x Mode

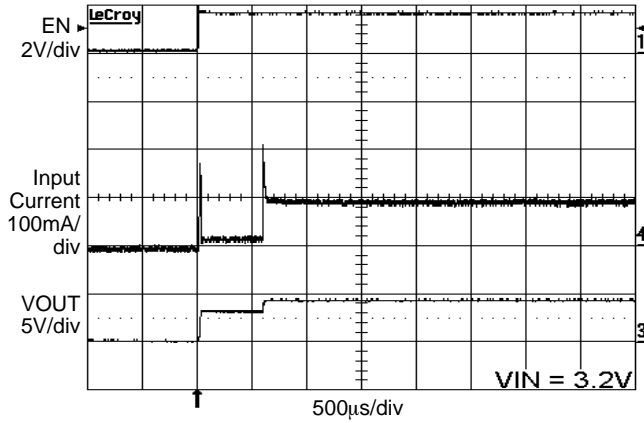

Figure 16. Power Up 3 LEDs at 20 mA, VIN = 3.2 V (1.5x Mode)

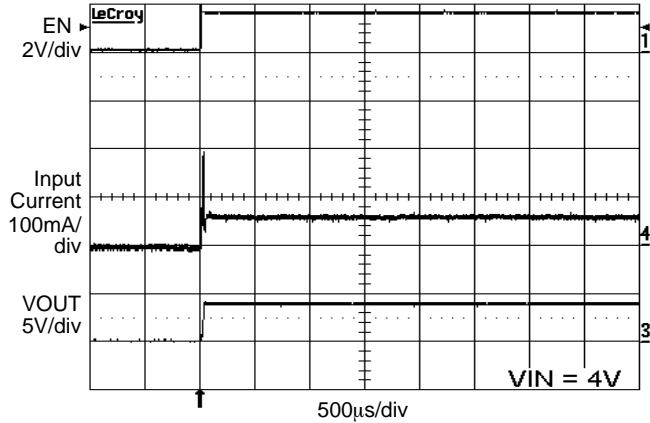

Figure 17. Power Up 3 LEDs at 20 mA, VIN = 4 V (1x Mode)

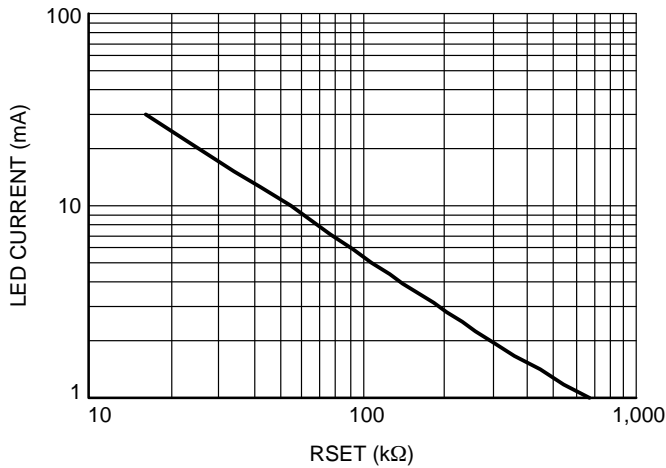

Figure 18. LED Current vs. RSET

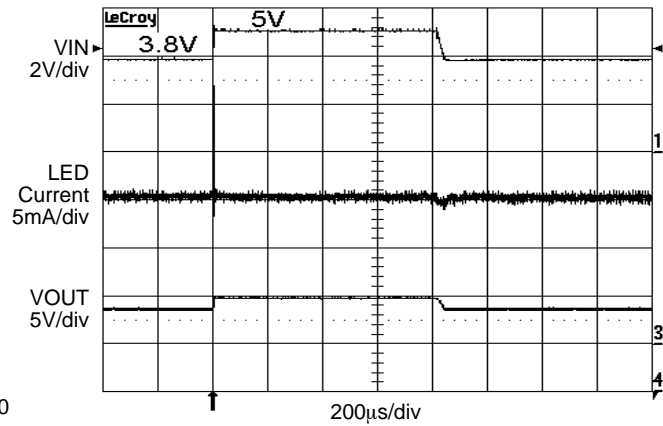

Figure 19. Line Transient Response in 1x Mode

CAT3603

Block Diagram

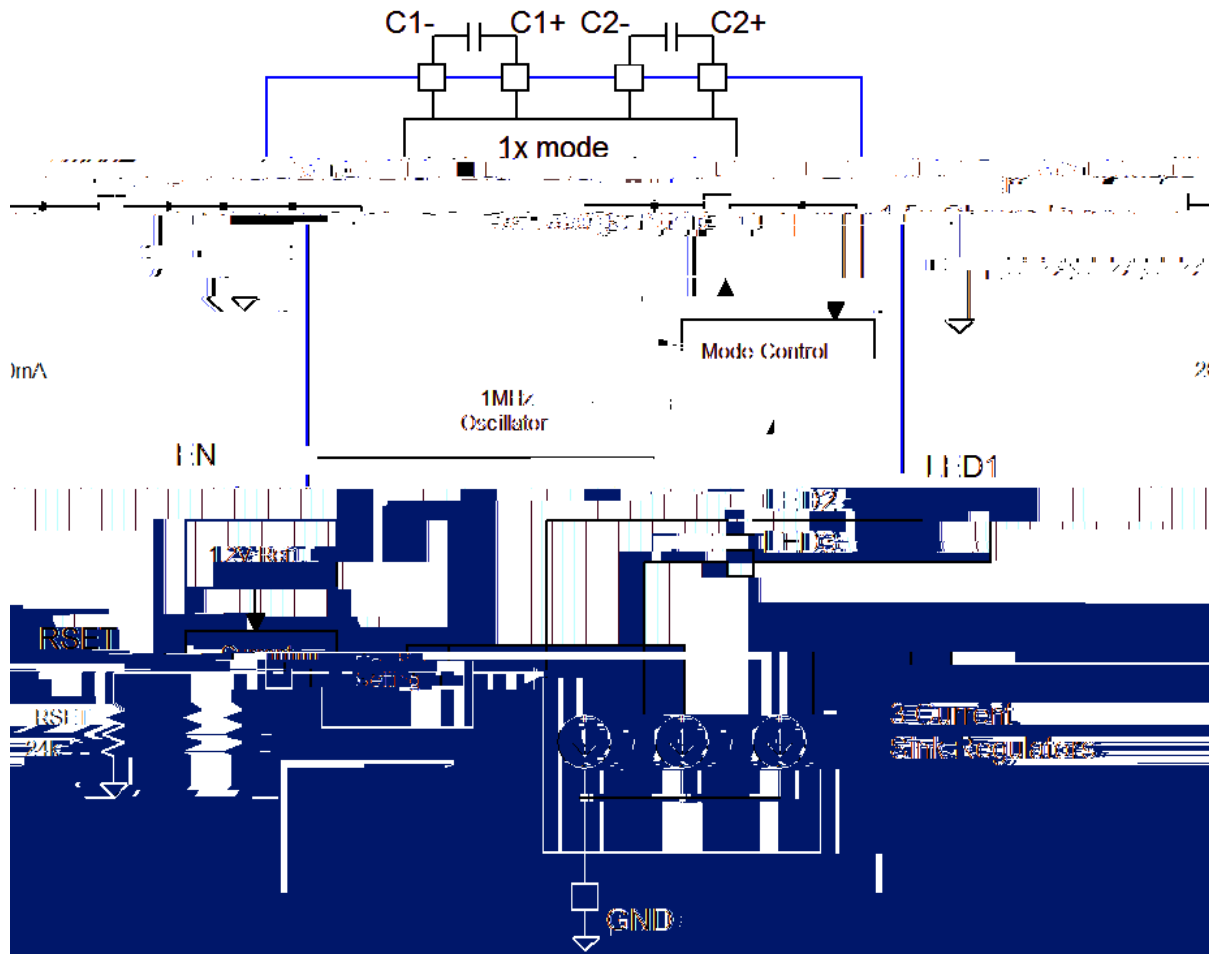

Figure 21. CAT3603 Functional Block Diagram

Basic Operation

CAT3603

TDFN12, 3x3
CASE 511AN-01
ISSUE A

DATE 18 MAR 2009

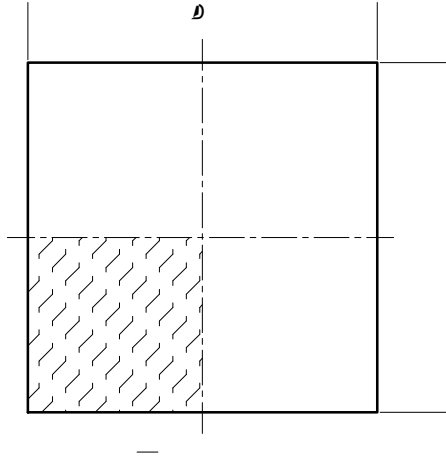

TOP VIEW

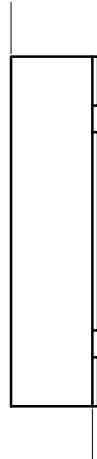

SIDE VIEW

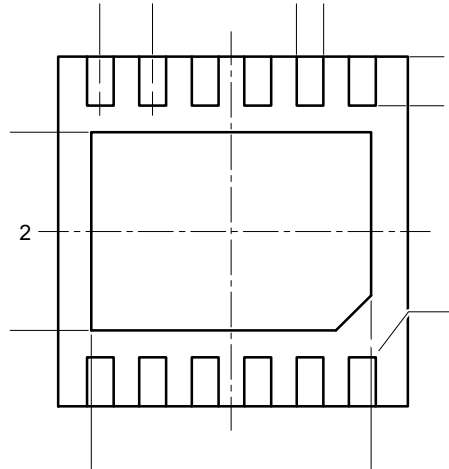

BOTTOM VIEW

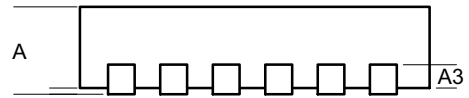

A1

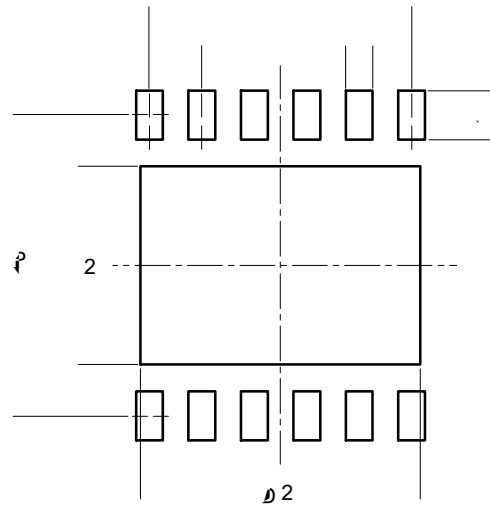

onsemi, **onsemi**, and other names, marks, and brands are registered and/or common law trademarks of Semiconductor Components Industries, LLC dba "**onsemi**" or its affiliates and/or subsidiaries in the United States and/or other countries. **onsemi** owns the rights to a number of patents, trademarks, copyrights, trade secrets, and other intellectual property. A listing of **onsemi**'s product/patent coverage may be accessed at www.onsemi.com/site/pdf/Patent-Marking.pdf. **onsemi** reserves the right to make changes at any time to any products or information herein, without notice. The information herein is provided "as-is" and **onsemi** makes no warranty, representation or guarantee regarding the accuracy of the information, product features, availability, functionality, or suitability of its products for any particular purpose, nor does **onsemi** assume any liability arising out of the application or use of any product or circuit, and specifically disclaims any and all liability, including without limitation special, consequential or incidental damages. Buyer is responsible for its products and applications using **onsemi**
