

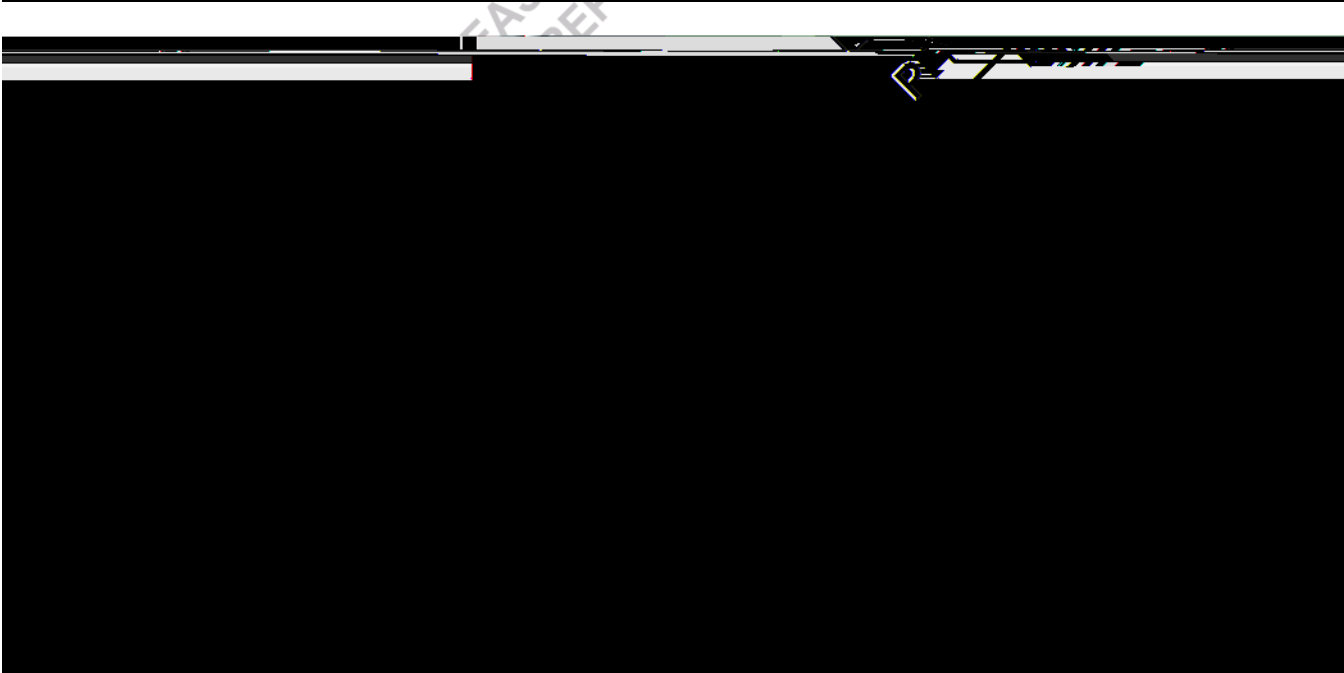

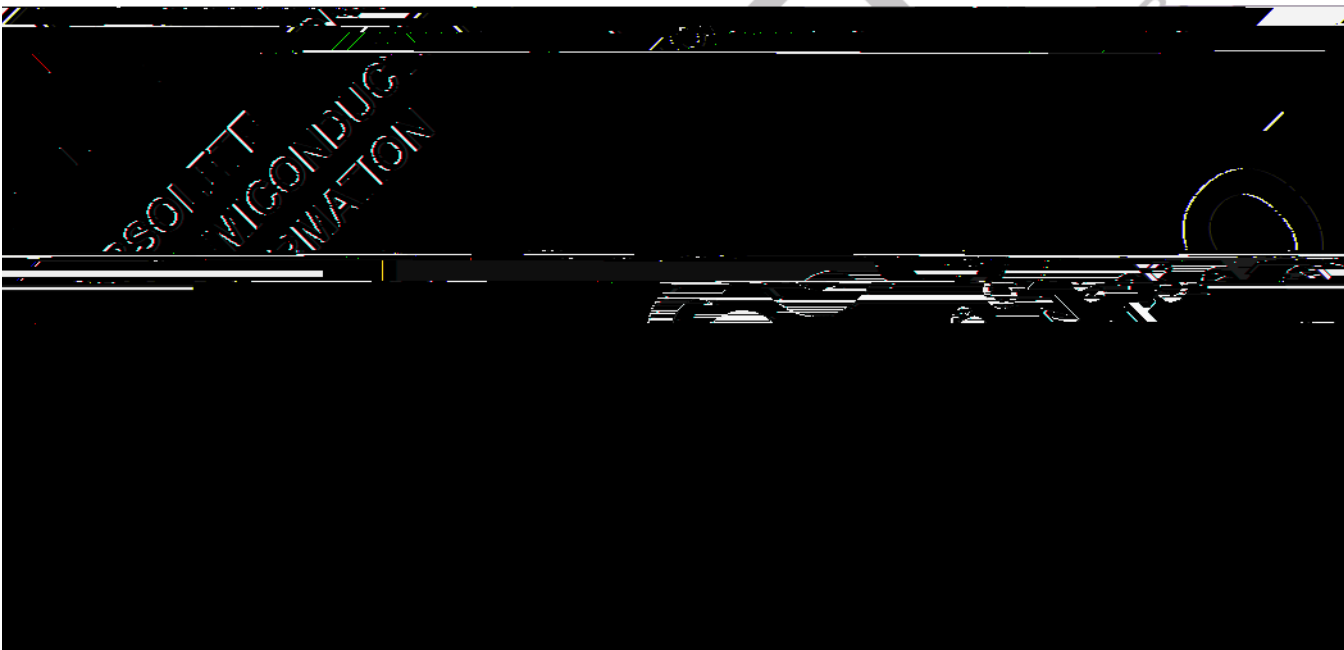

TE



# ADP –SPECIFICATIONS

$T_A$  °C to °C,  $V_{CC}$  unless otherwise noted.  $V, V_{BST} - V_{SW}$   $V, \overline{SD}$   $V, C_{DRVH}$   $C_{DRVL}$  nF,

Parameter	Symbol	Conditions	Min	Typ	Max	Unit
<b>SUPPLY (VCC)</b>						
Quiescent Current <sup>2</sup>	$I_{CCQ}$					
Shutdown Mode		$V_{SD} = 0.8 V$		30	65	$\mu A$
Operating Mode		$V_{SD} = 5 V, \text{No Switching}$		1.2	2	mA
<b>UNDERVOLTAGE LOCKOUT (UVLO)</b>						
UVLO Threshold	$V_{CCUVLO}$		3.9	4.15	4.5	V
UVLO Hysteresis	$V_{CCHUVLO}$			0.05		V
<b>LOW-SIDE DRIVER SHUTDOWN (<math>\overline{DRVLS}</math>)</b>						
Input Voltage High <sup>3</sup>	$V_{IH}$					

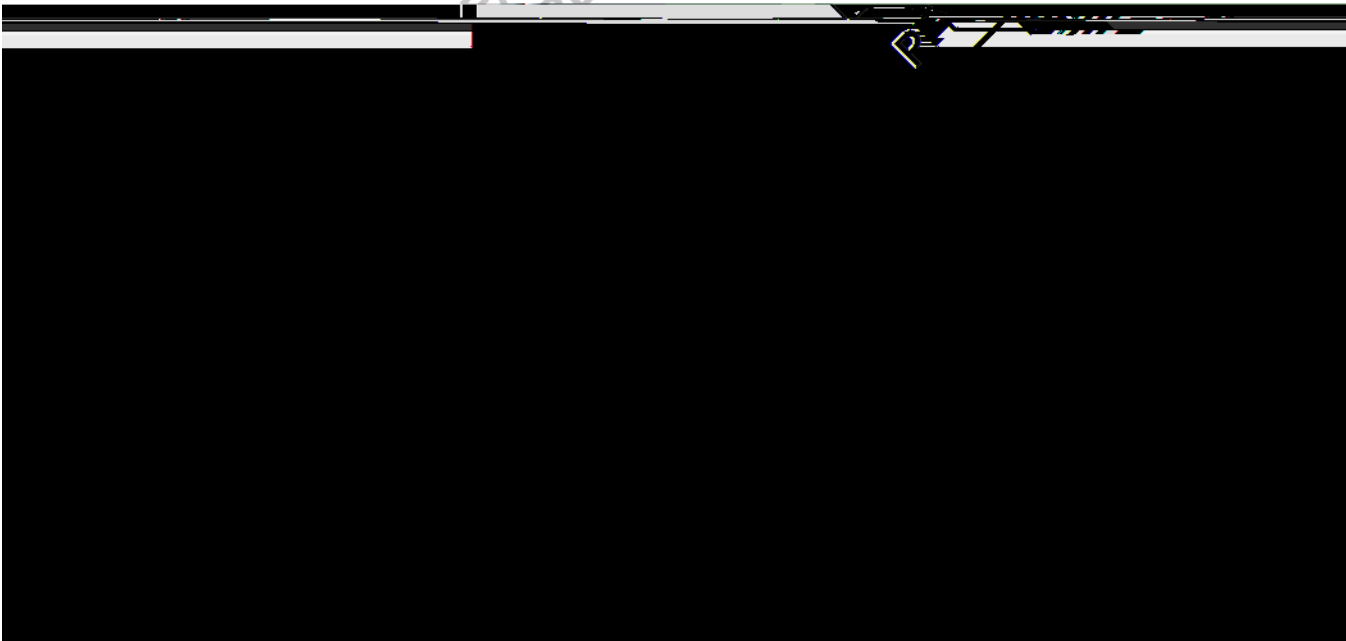
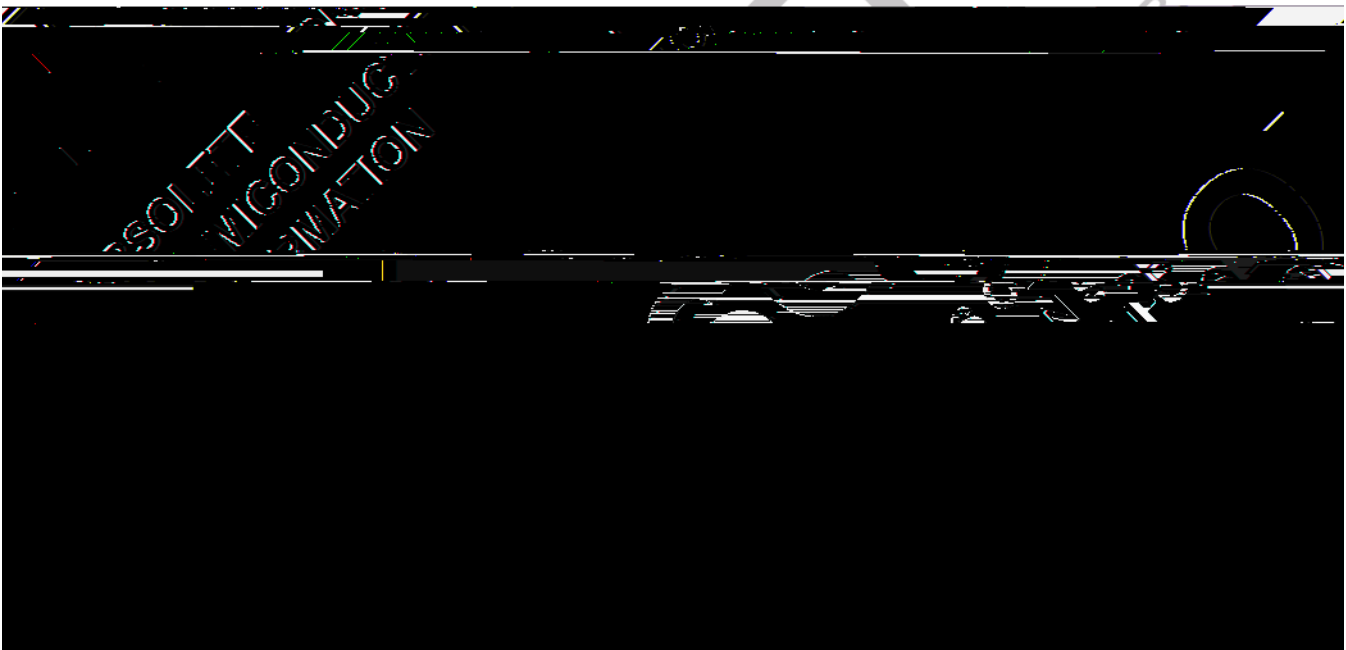



# ADP3415

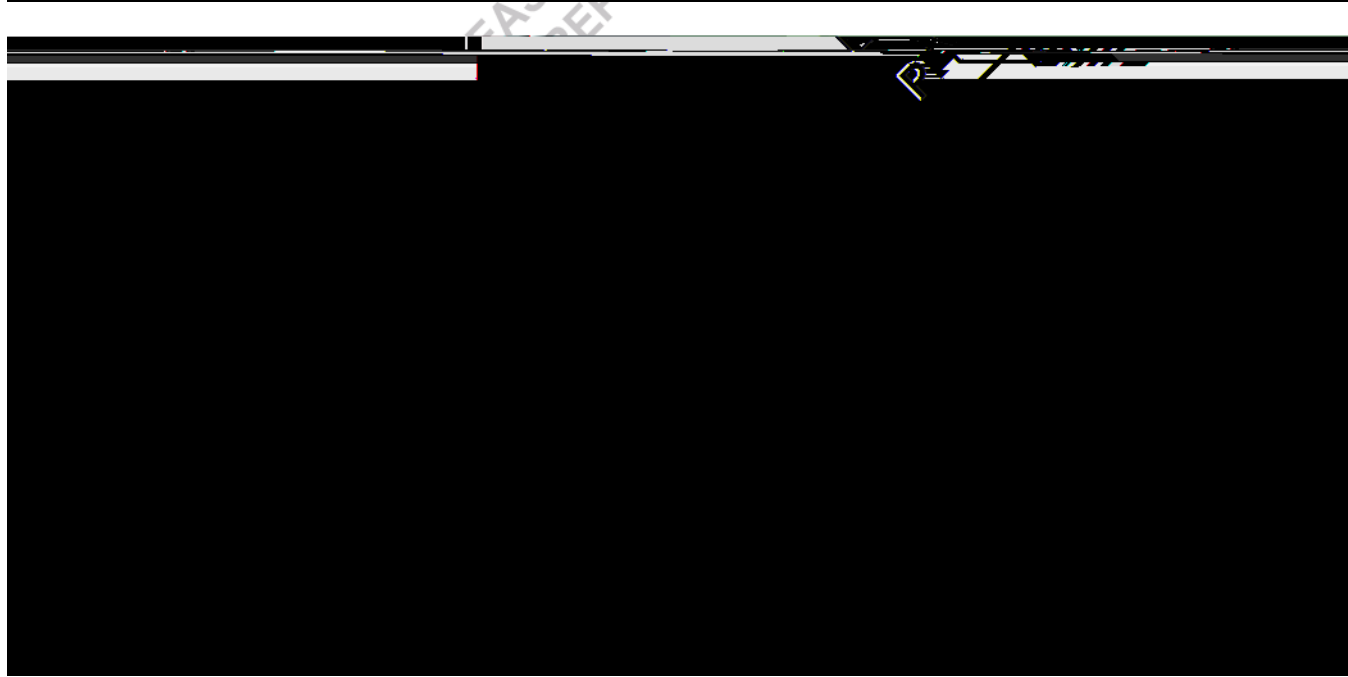
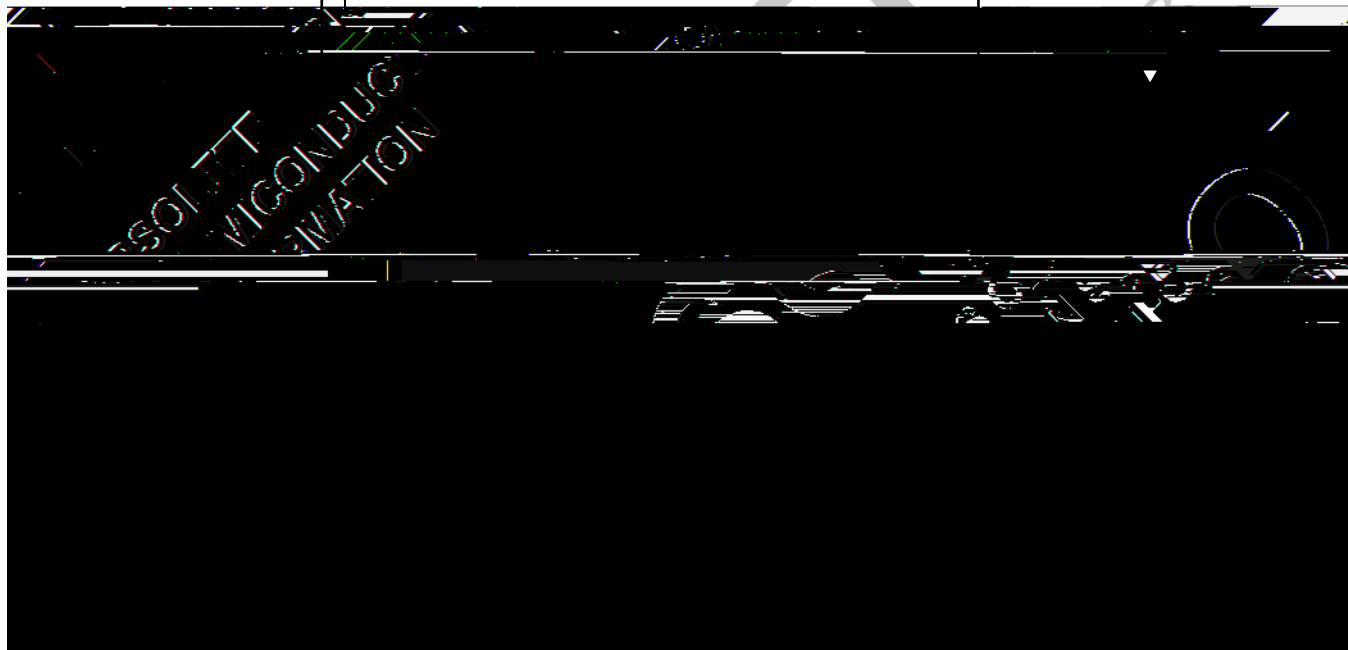
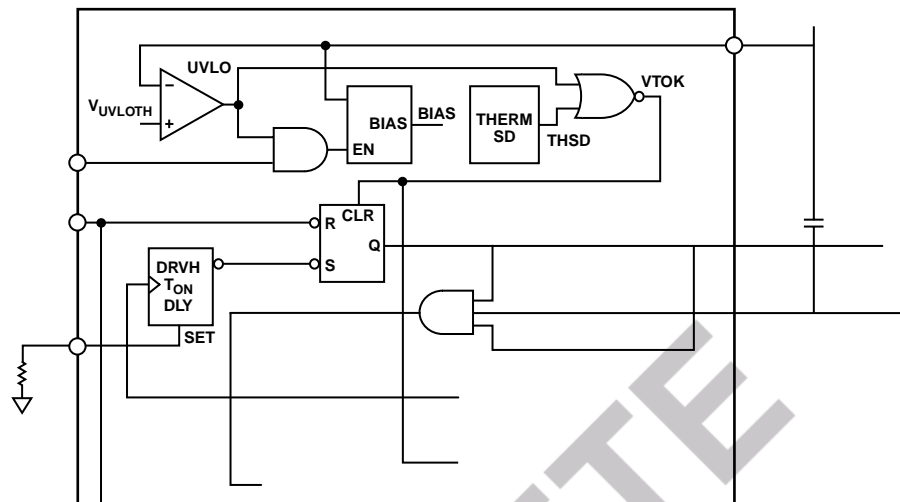

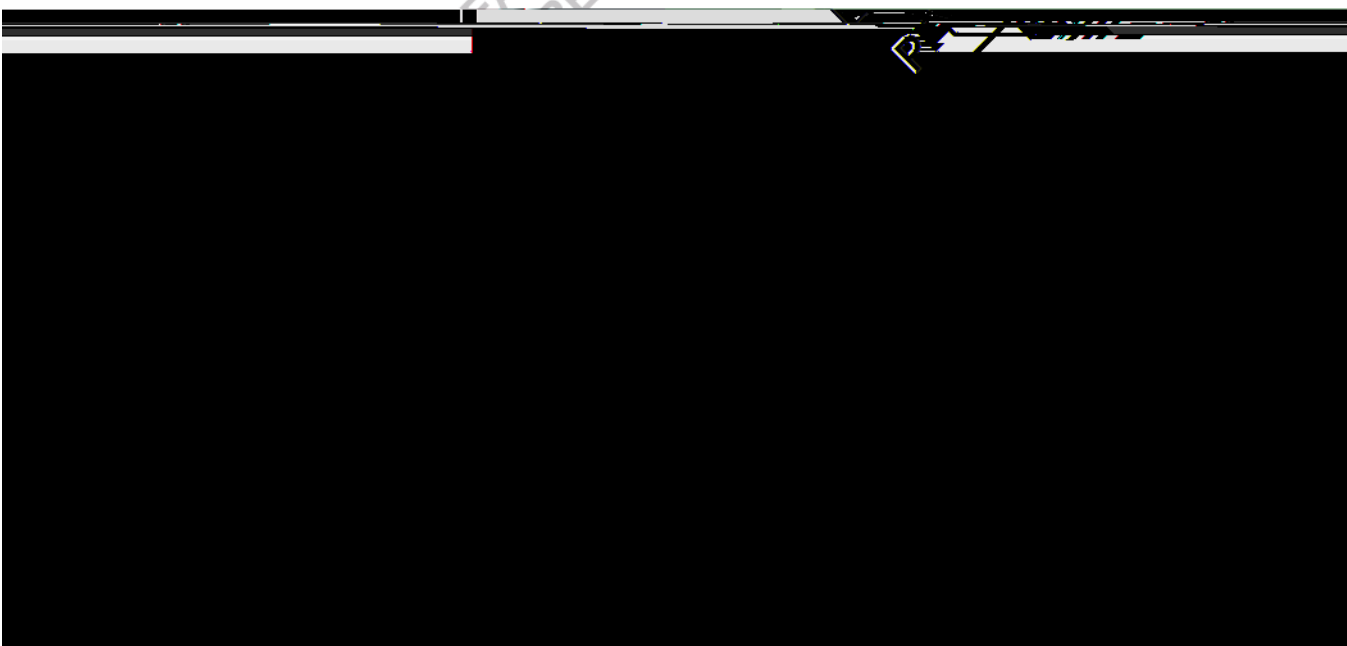
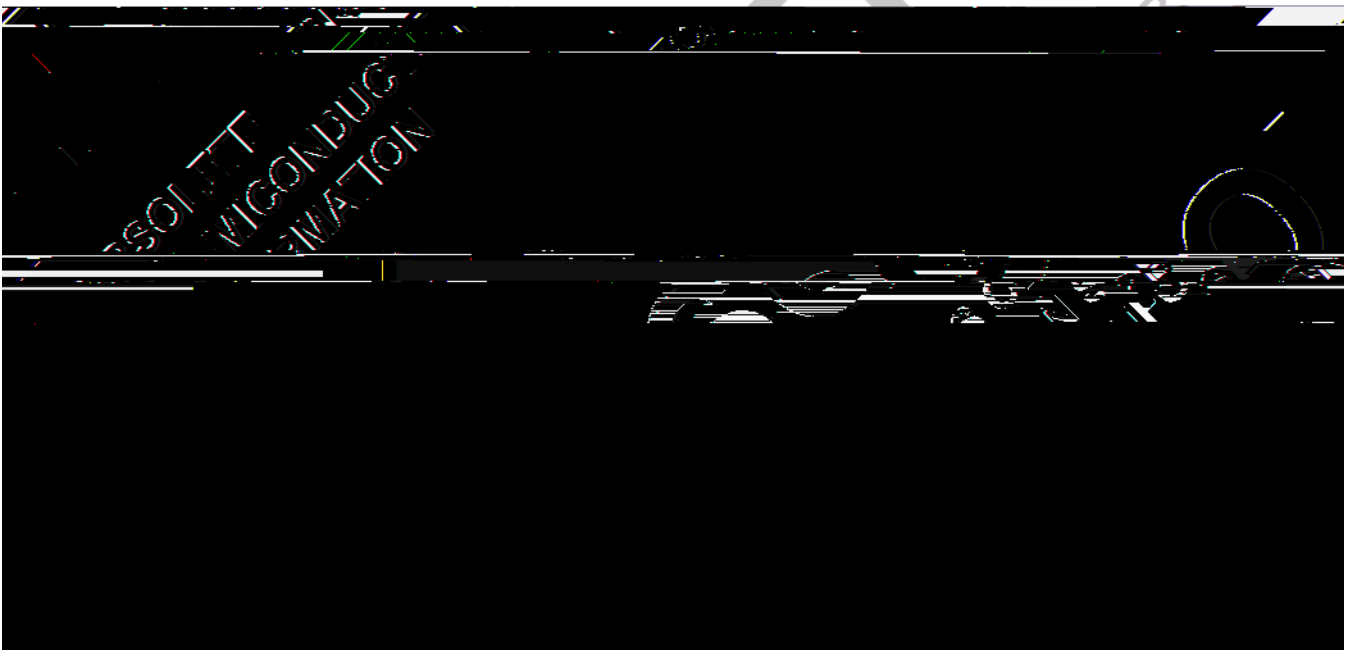
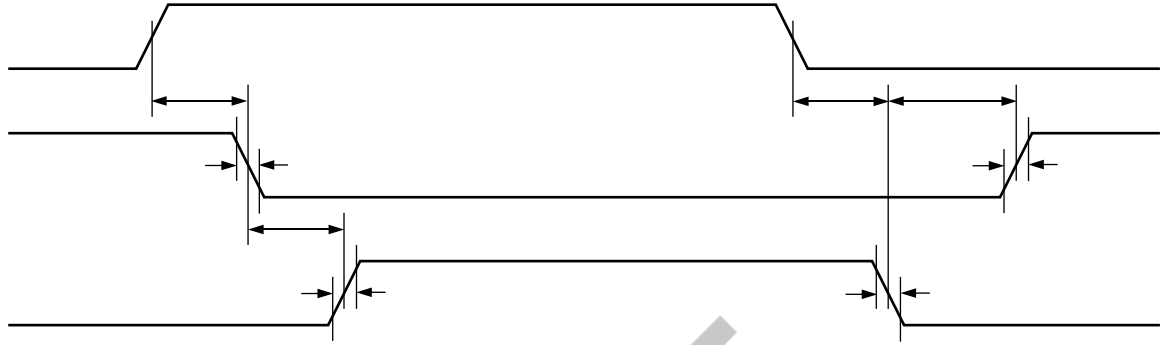

A<sub>1</sub>

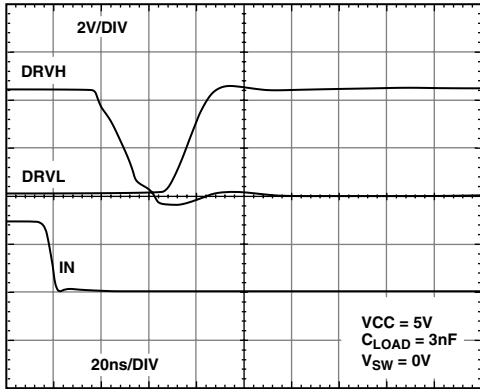

TIME - ns

C \_D H F n D . s . s

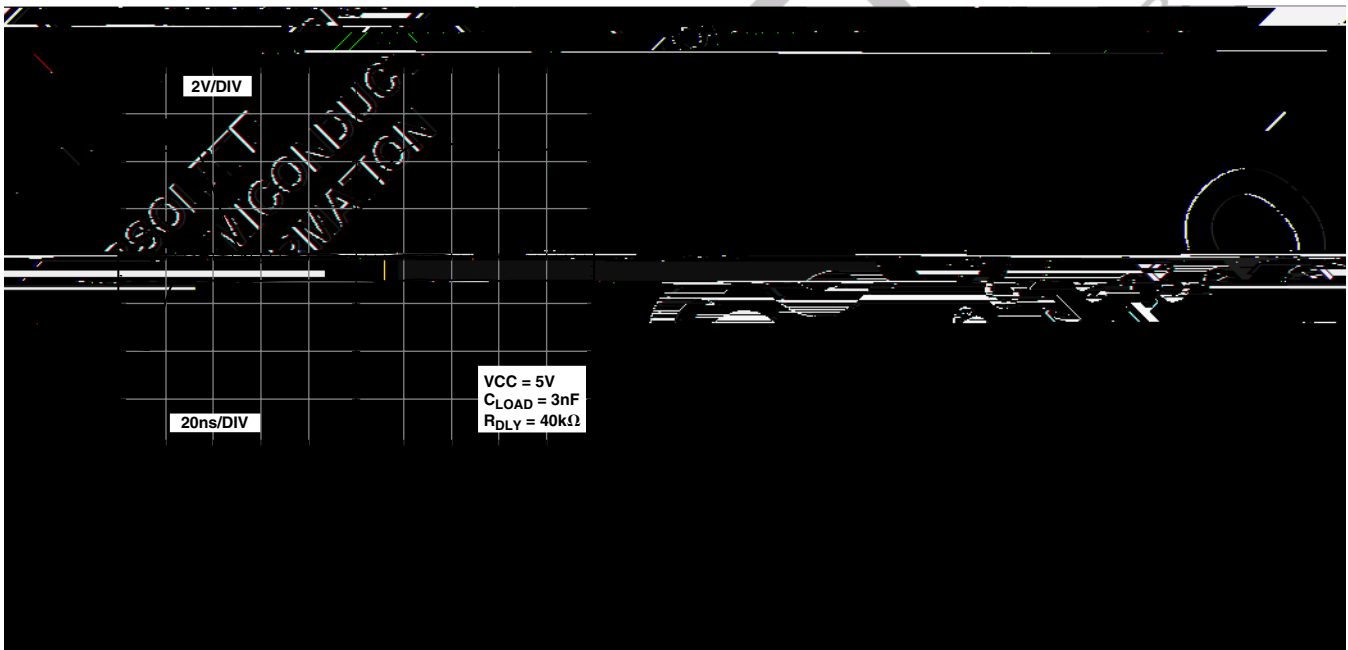



TE

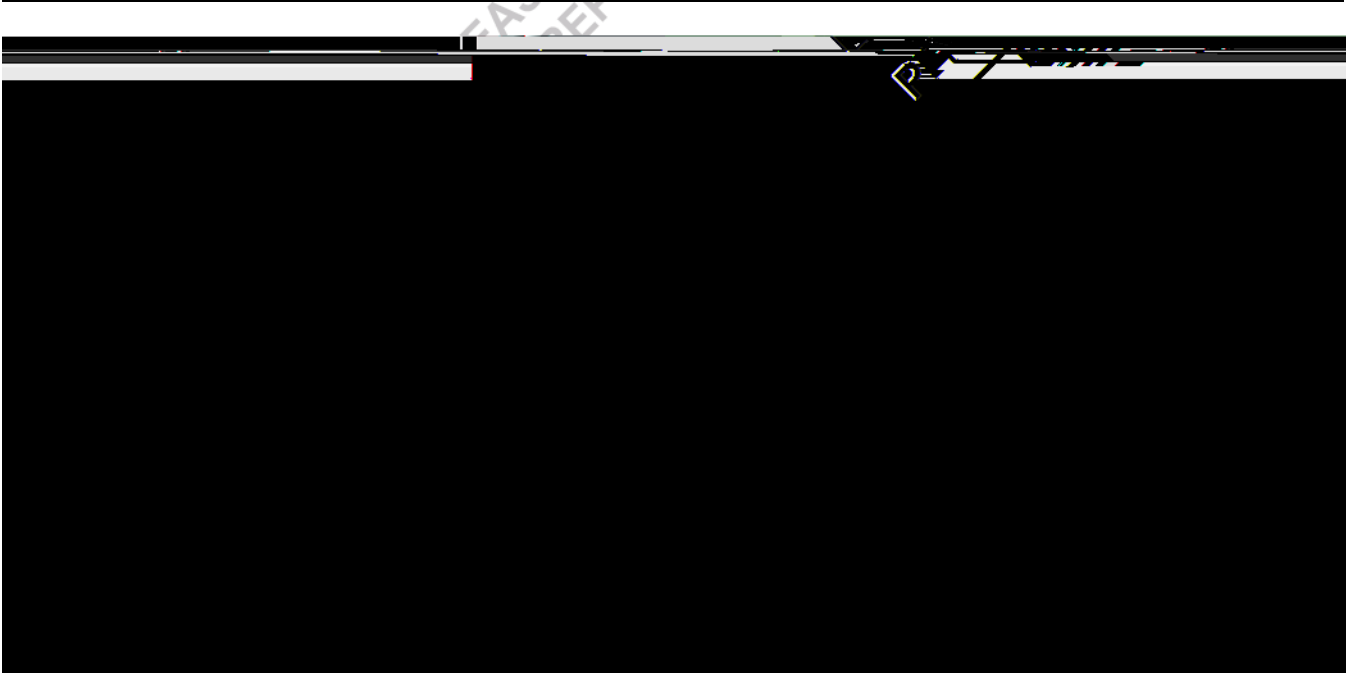
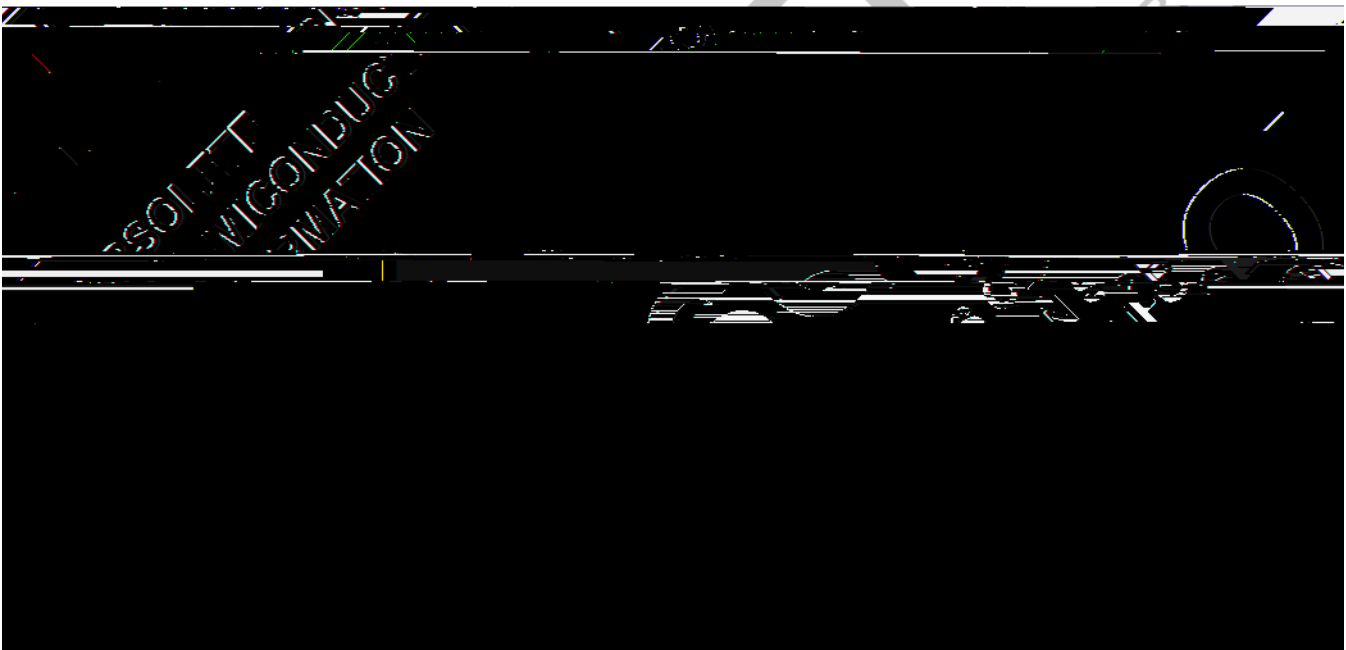



# ADP3415

## THEORY OF OPERATION

The ADP3415 is a dual MOSFET driver optimized for driving

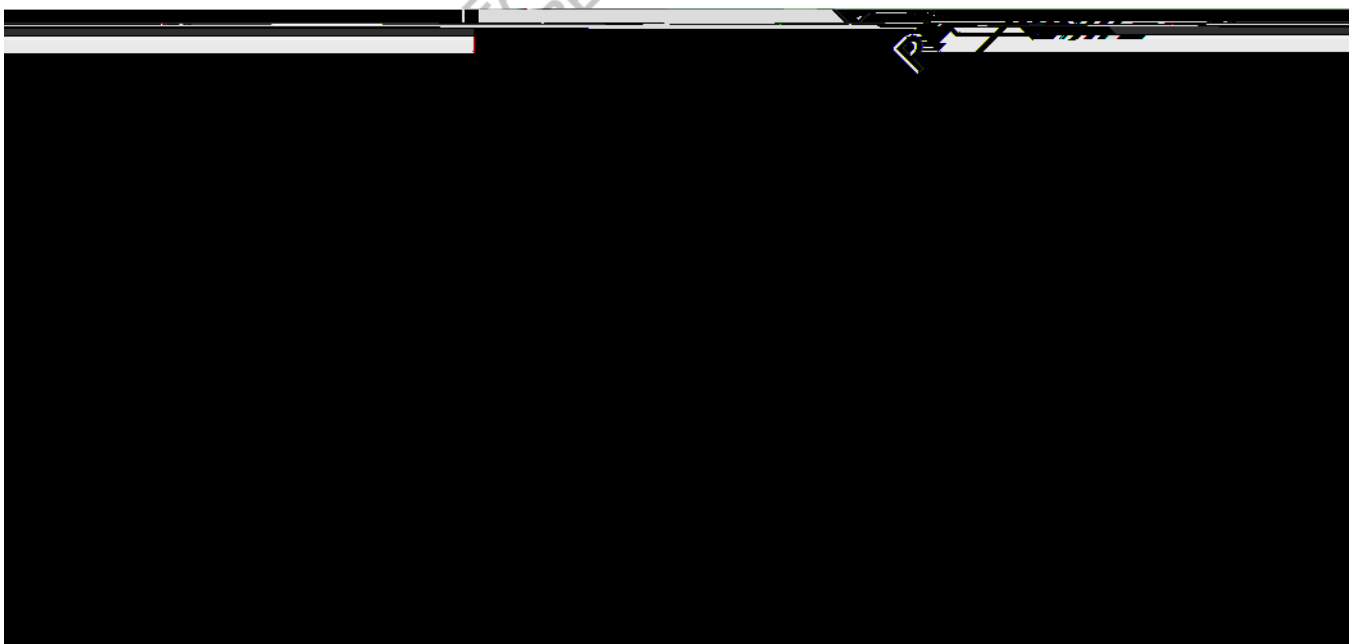
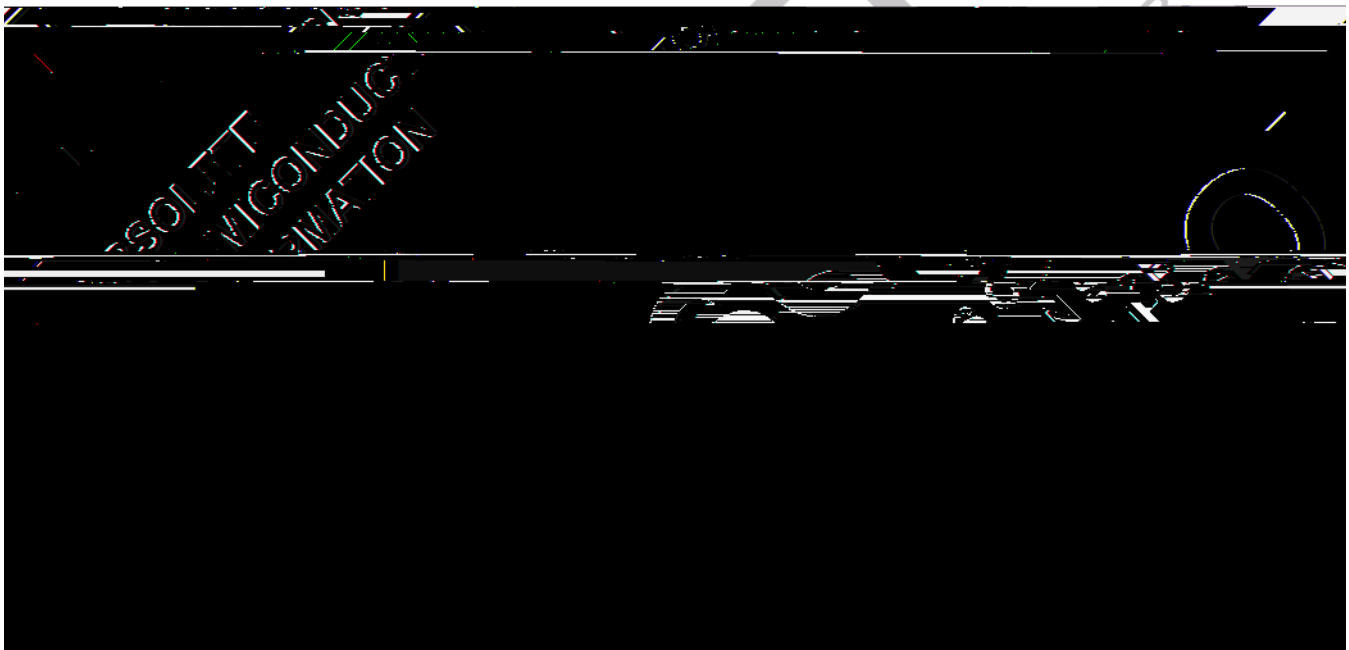

TE

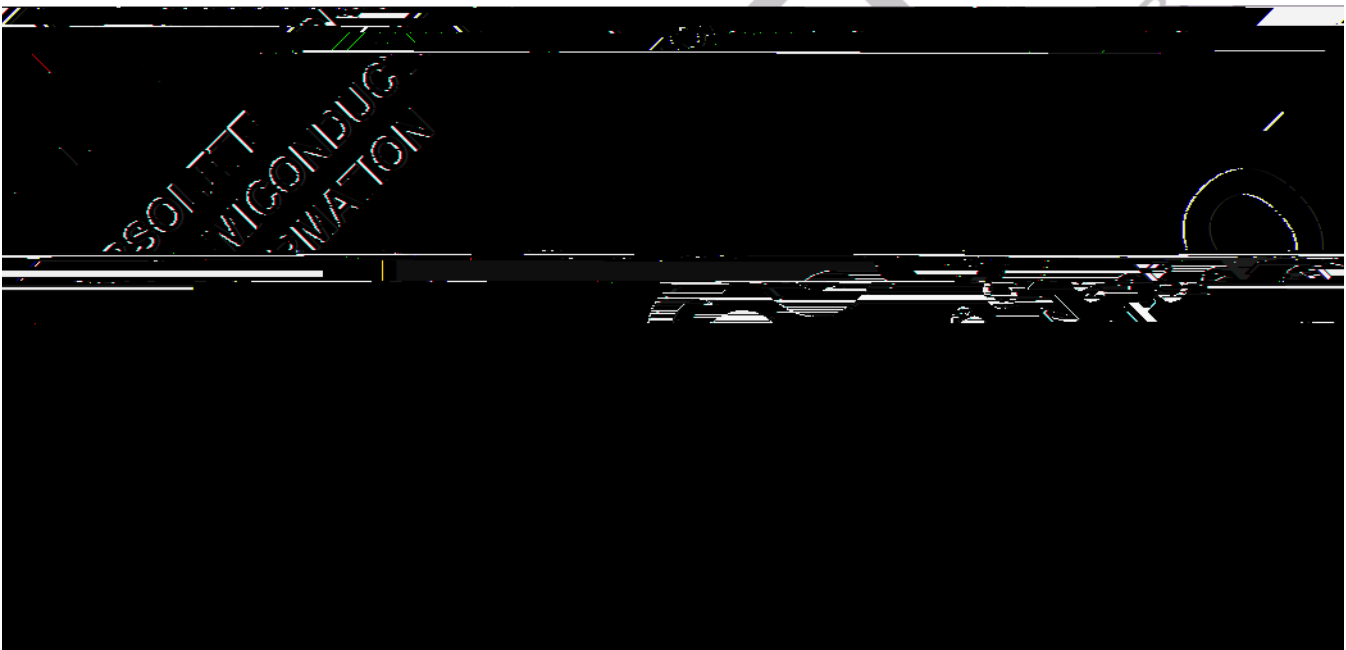

FA

